

Your success counts

Level Indicator with very large digits



Application examples: Extreme cold weather regions



Level monitoring at a tank / silo



Hot and sandy deserts

The F-Series is your first and safest choice for field mount indicators in safe and hazardous area applications. Especially in harsh weather conditions like rain, snow, salty atmospheres and temperatures between -40°C up to +80°C (-40°F up to 176°F).

Advantages

- Robust aluminum or stainless steel 316L field enclosure (IP67 / NEMA Type4X). It is so rugged, a truck can even stand on it!
- Intrinsically Safe available - ATEX, IECEx and CSA approval for gas and dust applications.
- Programming can be done by your own crew, with the sensible menu-driven structure, saving cost and irritation. Know one, know them all!
- Very diverse mounting possibilities: walls, pipes, panels or directly onto outdoor sensors!

Features

- Displays level and height or percentage filled.
- Very large 26mm (1") digits.
- Piegraph indication: ten segments.
- Number of digits for level: 5 ½.
- LED backlight option.
- Selectable on-screen engineering units: volumetric or mass.
- Level input signals: (0)4 - 20mA or 0 - 10V DC.
- Loop or battery powered, 8 - 30V DC or 115 - 230V AC power supply.
- Sensor supply 8.2 / 12 / 24V DC.
- Auto backup of all settings.
- Explosion/flame proof available, according ATEX/IECEx.

Introduction

The F070 is a straight forward level indicator. The measuring unit to be displayed is simply selected through an alfa-numerical configuration menu. No adhesive labels have to be put on the outside of the enclosure: a weather proof and user friendly solution! The configuration of the Span, off-set and number of decimals is done through software functions, without any sensitive dip-switches or trimmers. A wide selection of options further enhances the capabilities of this model, including Intrinsic Safety for hazardous area applications.

Configuration

All configuration settings are accessed via a simple operator menu which can be password protected. Each setting is clearly indicated with an alphanumeric description, which avoids confusing abbreviations. All settings are safely stored in EEPROM memory in the event of sudden power failure.

Hazardous areas

For hazardous area applications, this model is ATEX, IECEx and CSA certified as Intrinsically Safe for gas and dust applications, with an allowed ambient temperature of -40°C to +70°C (-40°F to +158°F). A flame proof Ex d enclosure with ATEX/IECEx certification is also available.



Display

The display has very large 26mm (1") digits which can be set to show level and height or percentage filled. As the F070 has been designed for field mounted applications, a smart display update function has been incorporated. Related to the lower temperatures, the update frequency of the LCD is tuned automatically to achieve a readable display even at -40°C / -40°F.

Backlight

For those applications where readability during day and night is an issue, a white backlight is available. The intensity can be adjusted from the keyboard. The display is a transfective type, which means that a high contrast reading is guaranteed in full sunlight as well as during the night. This backlight option is also available Intrinsically Safe.



All info at a glance



Easy to install



Easy to program



Know one know them all!



Reliable



User-friendly

Overview application F070

The F-Series is your first and safest choice for field mount indicators in safe and hazardous area applications. Especially in harsh weather conditions like rain, snow, salty atmospheres and temperatures between -40°C up to +80°C (-40°F up to 176°F). Applications where a basic level measurement display is required without level monitoring and linearisation. More sophisticated models: F073, F077, F170, F173 and F190 or the D-Series DIN panel mount indicators.

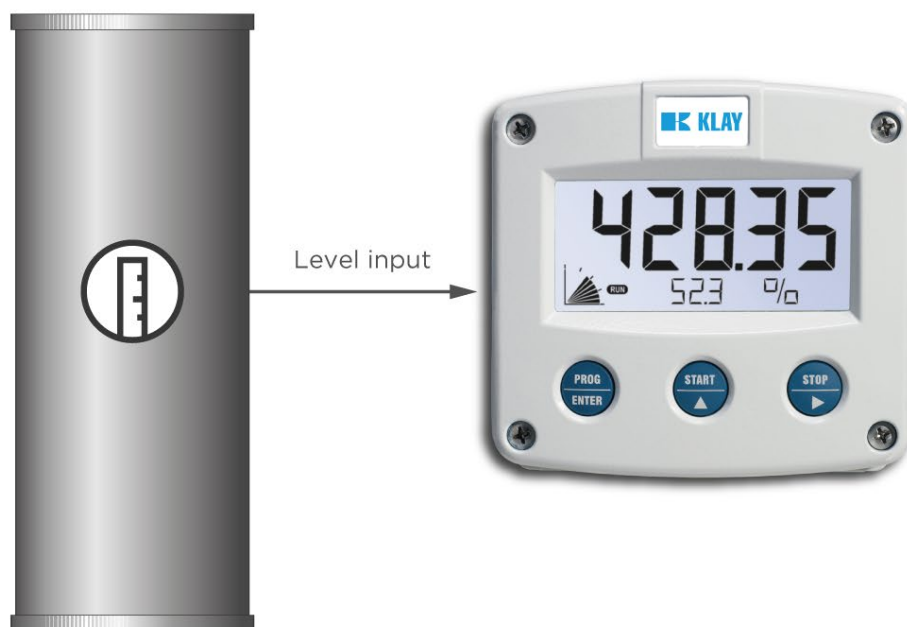

Signal input

The F070 accepts (0)4 - 20mA and 0 - 10V input signals from any type of level measurement device. Also a 4 - 20mA input loop powered model is available.

Power requirements

Several power supply options are available to power the F070 and sensor. A battery powered version with a long life lithium battery which will last up to five years. A 4-20mA input loop powered version is available as well. A real sensor supply is offered with the 24V AC/DC or 115-230V AC power requirement options.



Robust, even a truck can stand on it!



Resistant to harsh weather

Enclosures

Various types of enclosures can be selected, all ATEX, IECEx and CSA approved. The F070 is supplied in an GRP panel mount enclosure as standard, which can be converted to an IP67 / NEMA Type4X GRP field mount enclosure by the addition of a back case. Most popular is our robust aluminum field mount enclosure which is also available with an extended backcover with undrilled preparation for direct meter mounting at the back side. It is so rugged, even a truck can stand on it! For the most challenging environments we have a durable high grade Stainless steel 316L enclosure. All enclosures have a IP67 / NEMA Type4X rating and EU or U.S. cable gland entry threads available.

Dimensions enclosures

Aluminum & GRP panel mount enclosure

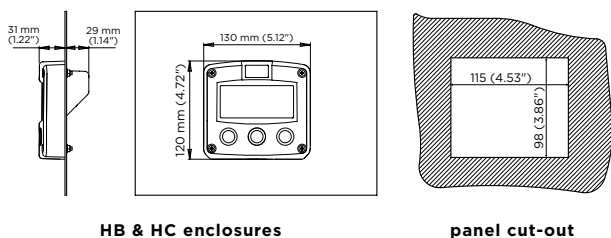

HB & HC enclosures

panel cut-out

Cable entries

Aluminum / Stainless Steel

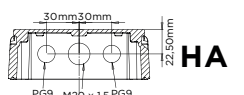

HA

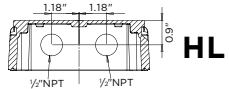

HL

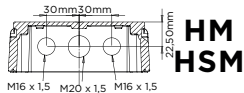

HM HSM

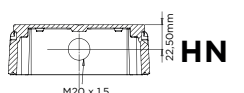

HN

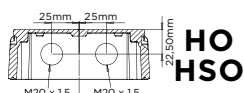

HO HSO

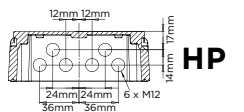

HP

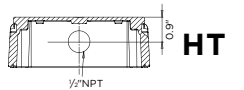

HT

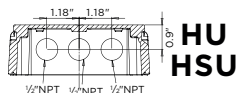

HU HSU

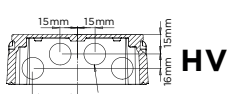

HV

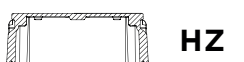

HZ

GRP



HD

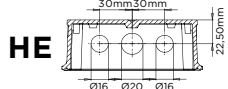

HE

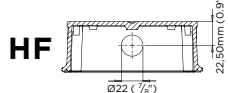

HF

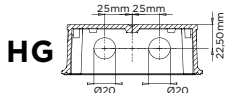

HG

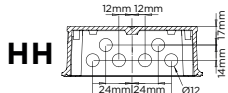

HH

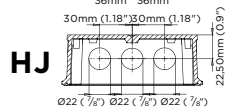

HJ

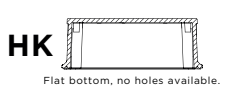

HK

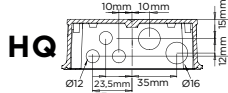

HQ

Extended Aluminum

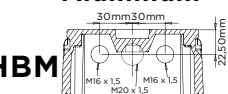

HBM

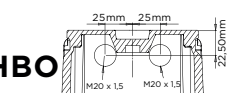

HBO

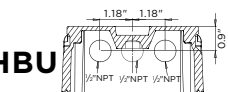

HBU

Aluminum, GRP & Stainless steel 316L field mount enclosures

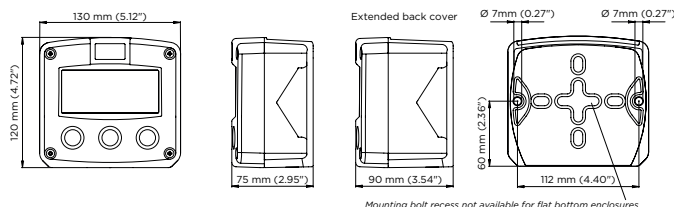

Mounting bolt recess not available for flat bottom enclosures.

Terminal connections PB/PC - PD - PL - PX

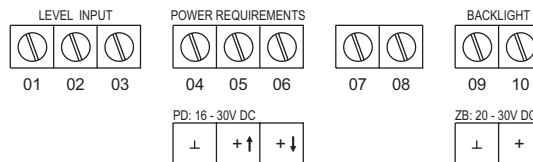

PD: 16 - 30V DC
 PL: input loop powered.
 PX: 8 - 30V DC
 PB / PC: battery powered (PX is also available: if an external supply is connected, the battery supply will be switched off / on automatically).

Terminal connections PF - PM

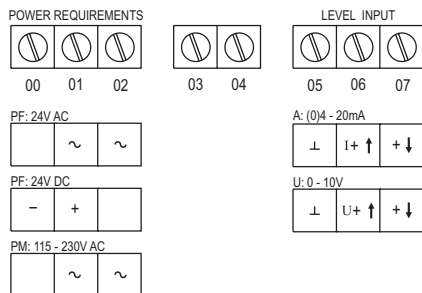

Configuration example F070-A-PB-(PX)-XX-(ZB)

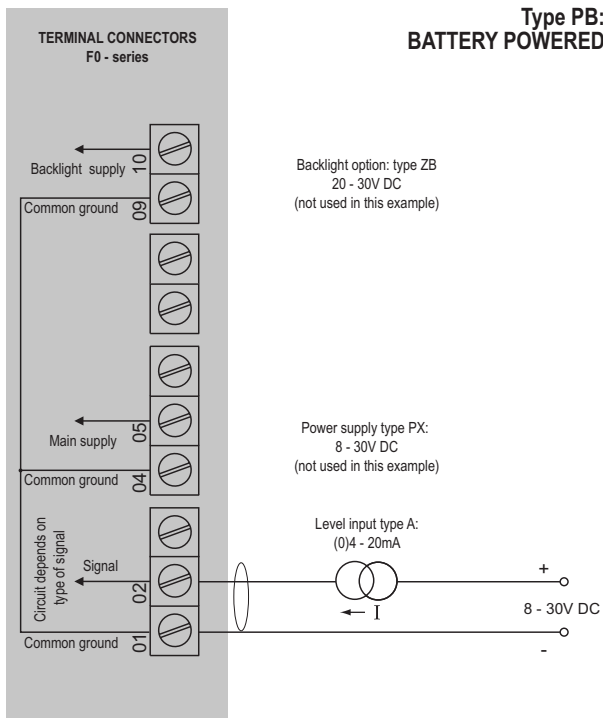

* Sensor supply voltage: Terminal 3: not available.

Configuration example F070-A-PL-XX-ZB

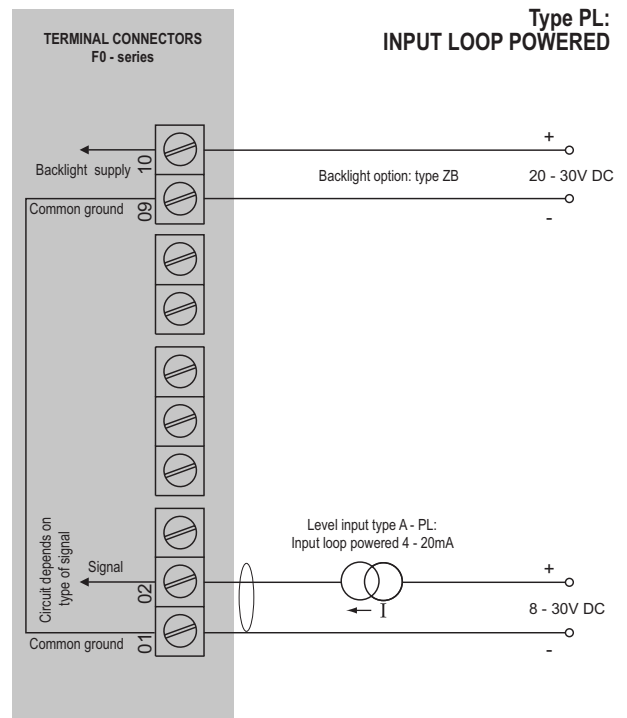

Sensor supply: sensor is externally powered.

Configuration example F070-A-PD-XX-ZB

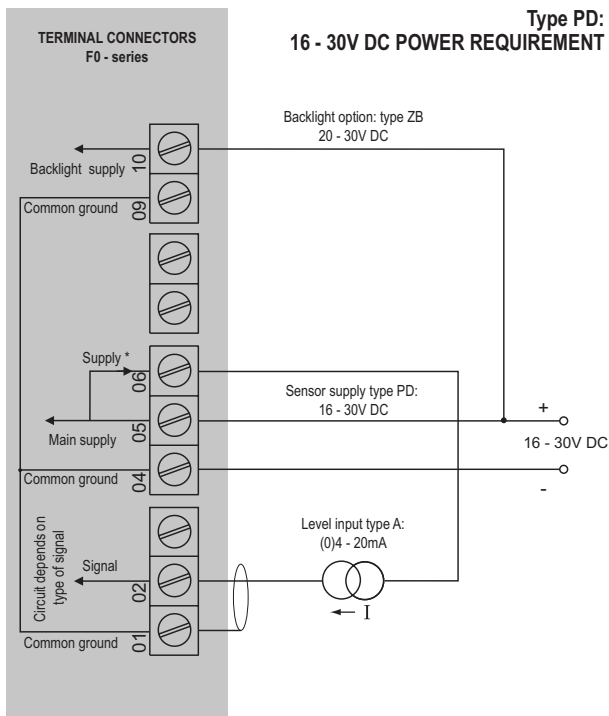

* Sensor supply voltage: Terminal 3: not available.
Terminal 6 with type PD: voltage as connected to terminal 5 (internally linked).

Configuration example F070-A-PM-XX-ZB

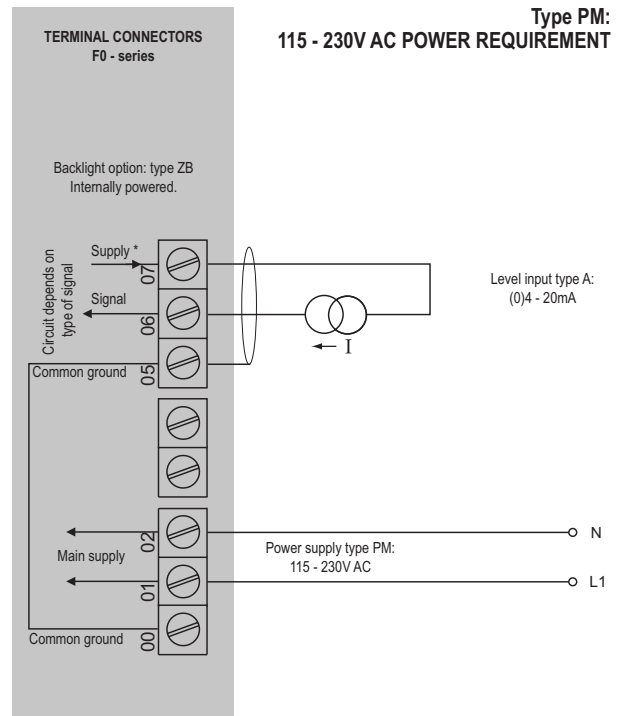

* Sensor supply voltage: Terminal 7: 8.2 / 12 / 24V DC.

Hazardous area applications

The F070-XI has been certified according to ATEX and IECEx by DEKRA and according to CSA c-us and FM for use in Intrinsically Safe applications with an ambient temperature of -40°C to +70°C (-40°F to +158°F). For equipment category 1 D (EPL Da), -40°C to +50°C (-40°F to +122°F).

- The ATEX markings for gas and dust applications are:



Gas: **II 1 G Ex ia IIC T4 Ga.**



Dust: **II 1 D Ex ia IIIC T₂₀₀ 100 °C Da.**

- The IECEx markings for gas and dust applications are:

Gas: **Ex ia IIC T4 Ga**

Dust: **Ex ia IIIC T₂₀₀ 100 °C Da.**

- The CSA c-us markings are:

IS Class I/II/III, Division 1, Groups A to G T4.

Class 1 Zone 0 AEx ia IIC T4 Ga.

Ex ia IIC T4 Ga.

It is allowed to connect up to three I.S. power supplies to power the unit, sensor and backlight. Consult the certificate for the maximum input and output values of the circuits.

Note: Extended aluminum enclosures are not available with CSA c-us approval.

The F070-PD-XI offers the input voltage to power an analog sensor. An ATEX/IECEx approved flame proof Ex d enclosure is available as well. Please contact your supplier for further details.

Certificate of conformity KEMA 05ATEX1168 X • IECEx KEM 08.0006X

• CSA.08.2059461



Configuration example IIA - IIB and IIC - F070-A-PX-XI-ZB - Basic power requirement 8 - 30V DC

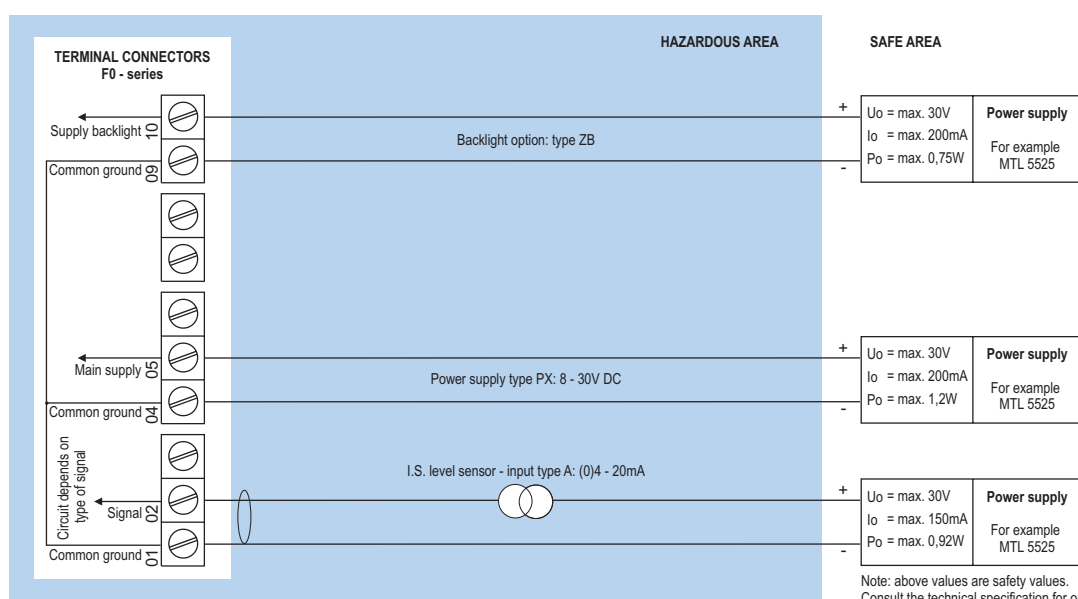

* Sensor supply voltage for analog level sensor type A / U: not available in this example. Please note: type PX may be used in combination with the battery (type PC). PX will power the unit; the battery will be disabled automatically till power is disconnected.

Configuration example IIA - IIB and IIC - F070-A-PD-XI-ZB - Power requirement 16 - 30V DC

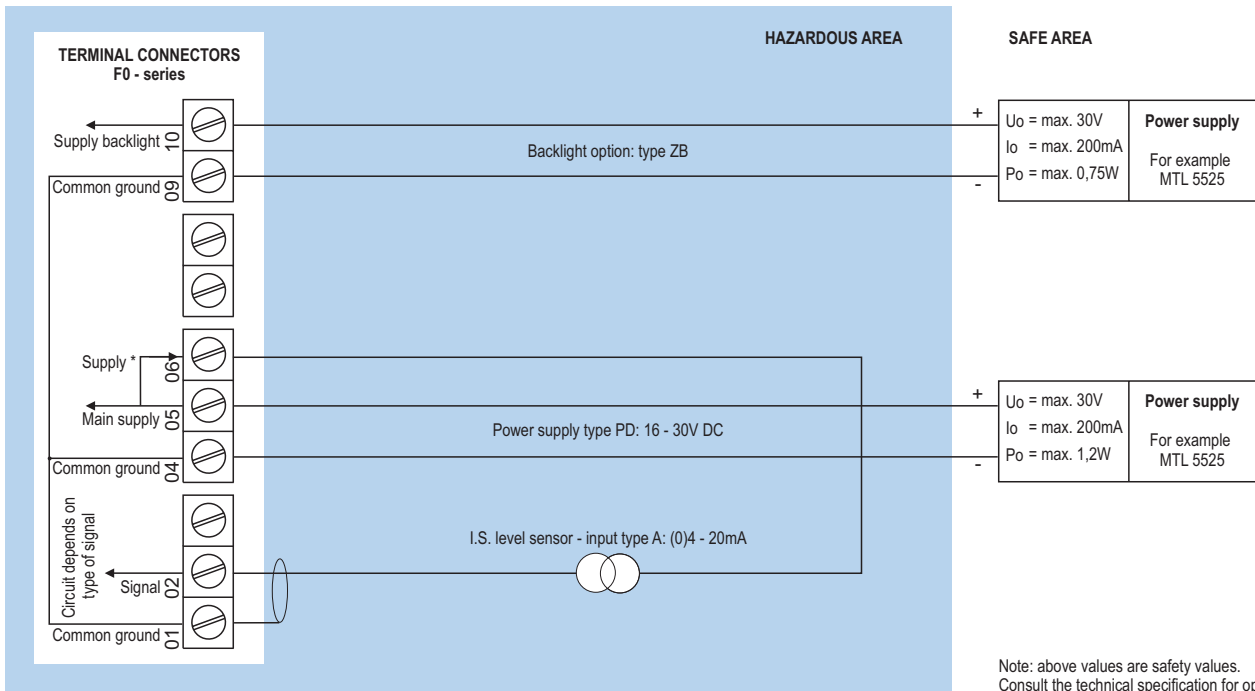

* Sensor supply voltage for analog level sensor type A / U: Terminal 6: as input voltage terminal 5 (internally linked).
 Please note: type PD may be used in combination with the battery (type PC). PD will power the unit; the battery will be disabled automatically till power is disconnected.

Configuration example IIA - IIB and IIC - F070-A-PL-XI-ZB - Input loop powered

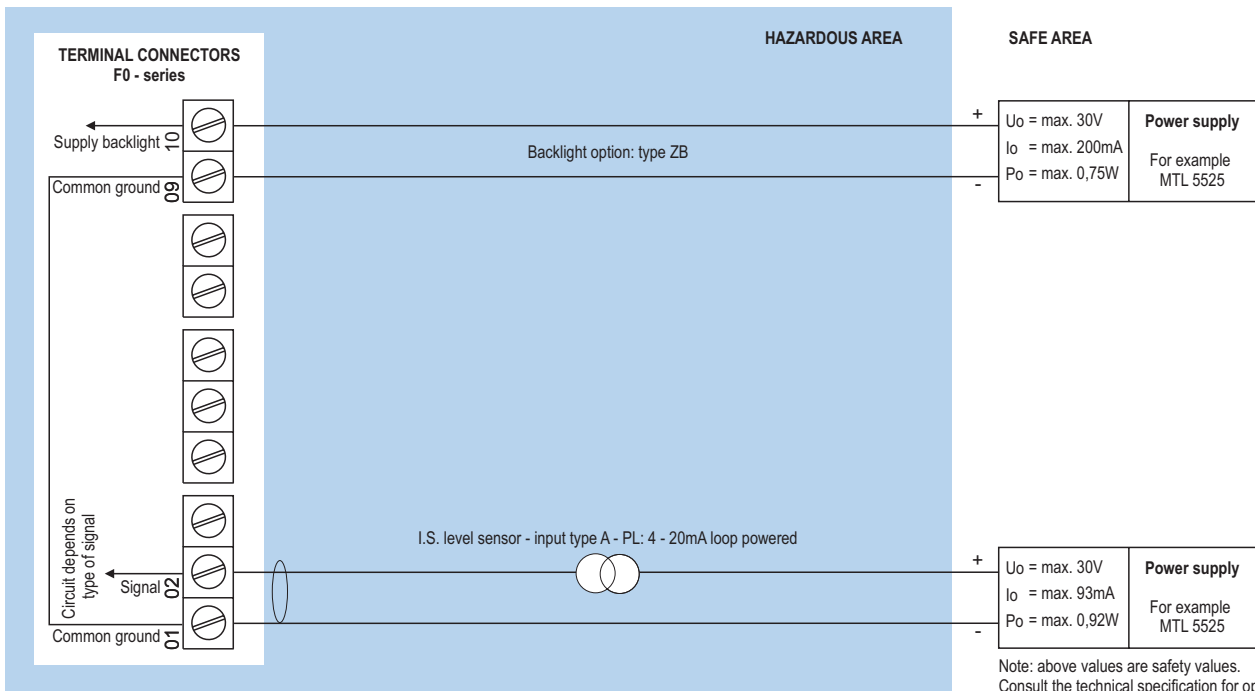

Sensor supply is not available: unit is input loop powered (type PL).
 Please note: type PL may be used in combination with the battery (type PC). PL will power the unit; the battery will be disabled automatically till power is disconnected.

Display

Type	High intensity reflective numeric and alphanumeric LCD, UV-resistant.
Dimensions	90 x 40mm (3.5" x 1.6").
Digits	5 ½ very large 26mm (1") digits. Various symbols and measuring units.
Piegraph	Ten segments - related to the input signal.
Refresh rate	User definable: fast, 1sec, 3sec, 15sec, 30sec, off.
Option ZB	Transflective LCD with white LED-backlight. Intensity can be adjusted in the configuration menu. Good readings in full sunlight and darkness. Also available Intrinsically Safe.

Ambient temperature

Safe areas	-40°C to +80°C (-40°F to +176°F).
EPL Ga / 1G	-40°C to +70°C (-40°F to +158°F).
EPL Da / 1D	-40°C to +50°C (-40°F to +122°F). max. dust layer thickness: 200mm.
EPL Db / 2D	-40°C to +70°C (-40°F to +158°F). max. dust layer thickness: 5mm.

Power requirements

Type PB	Long life Lithium battery - life-time depends upon settings and configuration - up to 5 years. (requires PD, PL or PX)
Type PC	Intrinsically Safe long life lithium battery - life-time depends upon settings and configuration - up to 5 years. (requires XI and PD, PL or PX)
Type PD	16 - 30V DC. power consumption max. 1W.
Type PF	24V AC / DC ± 10%. Power consumption max. 15W.
Type PL	Input loop powered from sensor signal 4 - 20mA (type "A").
Type PM	115 - 230V AC ± 10%. Power consumption max. 15W.
Type PX	8 - 30V DC. Power consumption max. 0.3W.
Type ZB	20 - 30V DC ± 10%. Power consumption max. 1W. With type PF / PM: internally powered.
Note PB/PF/PM	Not available Intrinsically Safe.
Note PF/PM	The total consumption of the sensor and backlight type ZB may not exceed 400mA @ 24V DC.
Note XI	For Intrinsically Safe applications, consult the safety values in the certificate.

Sensor excitation

Type PB/PC/PX	Not available.
Type PD	The sensor supply voltage will be according to power supply voltage (as connected to terminal 5).
Type PF / PM	8.2 / 12 / 24V DC - max. 400mA @ 24V DC.

Terminal connections

Type	Removable plug-in terminal strip. Wire max. 1.5mm ² and 2.5mm ² .
-------------	---

Data protection

Type	EEPROM backup of all settings. Data retention at least 10 years.
Password	Configuration settings can be password protected.

Directives & Standards

EMC	Directive 2014/30/EU, FCC 47 CFR part 15.
Low voltage	Directive 2014/35/EU
RoHS	Directive 2011/65/EU
ATEX / IECEx	Directive 2014/34/EU, IEC 600079-0, IEC 60079-11.
CSA	CSA 22.2 No. 157-92.
IP & NEMA	EN 60529 & NEMA 250.

Intrinsically Safe (Type XI)

ATEX	Gas: II 1 G Ex ia IIC T4 Ga. Dust: II 1 D Ex ia IIIC T ₂₀₀ 100 °C Da.
IECEX	Gas: Ex ia IIC T4 Ga. Dust: Ex ia IIIC T ₂₀₀ 100 °C Da.
CSA c-us	IS Class I/II/III, Division 1, Groups A to G T4. Class 1 Zone 0 AEx ia IIC T4 Ga. Ex ia IIC T4 Ga.
Note	Extended aluminum enclosures are not available with CSA c-us/FM approval.

Explosion proof (Type XF)

ATEX/IECEX	Gas: II 2 G Ex db IIB+H2 T5 Gb. Dust: II 2 D Ex tb IIIC T80°C.
Protection	IP66
Type XF	Dimensions of enclosure: 300 x 250 x 200mm (11.8" x 9.9" x 7.9") L x H x D.
Weight	Appr. 15kg.

Enclosure

Window	Polycarbonate window.
Sealing	Silicone.
Control keys	Three industrial micro-switch keys. UV-resistant silicone keypad.

Panel mount enclosures

Dimensions	130 x 120 x 60mm (5.12" x 4.72" x 2.36") - W x H x D.
Panel cut-out	115 x 98mm (4.53" x 3.86") L x H.
Type HB	Die-cast aluminum panel mount enclosure IP65 / NEMA Type4X.
Weight	600 gr.
Type HC	GRP panel mount enclosure IP65 / NEMA Type4X, UV-resistant and flame retardant.
Weight	450 gr.
Type HSB	Die-cast stainless steel 316L IP67/NEMA Type4X.
Weight	1150gr.

GRP wall / field mount enclosures

General	GRP wall/field mount enclosure IP67 / NEMA Type4X, UV-resistant and flame retardant.
Dimensions	130 x 120 x 75mm (5.12" x 4.72" x 2.95") - W x H x D.
Weight	600 gr.
Type HD	Cable entry: no holes.
Type HE	Cable entry: 2 x Ø 16mm and 1 x Ø 20mm.
Type HF	Cable entry: 1 x Ø 22mm (7/8").
Type HG	Cable entry: 2 x Ø 20mm.
Type HH	Cable entry: 6 x Ø 12mm.
Type HJ	Cable entry: 3 x Ø 22mm (7/8").
Type HK	Flat bottom, cable entry: no holes.
Type HQ	Cable entry: 2 x Ø 16mm & 3 x Ø 12mm.

Aluminum wall / field mount enclosures

General	Die-cast aluminum wall/field mount enclosure IP67 / NEMA Type4X with 2-component UV-resistant coating. Extended back cover available with undrilled preparation for direct meter mounting.
Dimensions	130 x 120 x 75mm (5.12" x 4.72" x 2.95") - W x H x D. 130 x 120 x 90mm (5.12" x 4.72" x 3.54") - W x H x D.
Weight	1100 gr. / extended enclosure: 1310 gr.
Type HA	Cable entry: 2 x PG9 and 1 x M20.
Type HL	Cable entry: 2 x 1/2" NPT.
Type HM/HBM	Cable entry: 2 x M16 and 1 x M20.
Type HN	Cable entry: 1 x M20.
Type HO/HBO	Cable entry: 2 x M20.
Type HP	Cable entry: 6 x M12.
Type HT	Cable entry: 1 x 1/2" NPT.
Type HU/HBU	Cable entry: 3 x 1/2" NPT.
Type HV	Cable entry: 4 x M20.
Type HZ	Cable entry: no holes.
Note	Extended aluminum enclosures are not available with CSAc-us and FM approvals.
CSA c-us/FM	

Stainless steel 316L wall / field mount enclosures

General	Die-cast stainless steel 316L wall / field mount enclosure with flat bottom. IP67 / NEMA Type4X.
Dimensions	130 x 120 x 75mm (5.12" x 4.72" x 2.95") - W x H x D.
Weight	2700 gr.
Type HSM	Cable entry: 2 x M16 + 1 x M20.
Type HSO	Cable entry: 2 x M20.
Type HSU	Cable entry: 3 x 1/2" NPT.

Signal inputs - Level sensor

Type A	(0)4 - 20mA. Analog input signal can be scaled to any desired range within 0 - 20mA.
Type U	0 - 10V DC. Analog input signal can be scaled to any desired range within 0 - 10V DC.
Accuracy	Resolution: 16 bit. Error < 0.01mA / ± 0.05% FS. Low level cut-off programmable.
Span	0.001 - 199,999 with variable decimal position.
Offset	-99,999 / +199,999 units.
Update time	Four times per second.
Voltage drop	Type A: max. 1V DC @ 20mA.
Voltage drop	Type A - PL (loop powered): max. 2.6V DC @ 20mA.
Relationship	Linear and square root calculation.
Note A / U	For signal type A and U: external power to sensor is required; e.g. type PD.
Note A / U	Span for height is 0.01 / 199,999 with variable decimal position.

Operator functions

Displayed info	<ul style="list-style-type: none"> • Level • Height or percentage (or no indication).
-----------------------	---

Level

Digits	5 1/2 digits.
Units	L, m ³ , GAL, USGAL, kg, lb, bbl, no unit.
Decimals	0 - 1 - 2 or 3.

Height

Digits	6 digits.
Units	mm, cm, m, mtr, inch, ft, mmwk, mmwc, cmwk, cmwc, mwk, mwc, inwc, ftwc, mbar, bar, psi, no unit.
Decimals	0 - 1 or 2.

Percentage

Digits	3 digits.
Decimals	1.

Mounting accessories

ACF02	Stainless steel wall mounting kit.
ACF05	Stainless steel pipe mounting kit (worm gear clamps not included).
ACF06	Two stainless steel worm gear clamps Ø 44 - 56mm.
ACF07	Two stainless steel worm gear clamps Ø 58 - 75mm.
ACF08	Two stainless steel worm gear clamps Ø 77 - 95mm.
ACF09	Two stainless steel worm gear clamps Ø 106 - 138mm.
ACF11	Swivel with 25° movement from center axis for direct flowmeter mounting: 1" NPT to 1/2" NPT.

		Description
Model	F070	Level indicator with very large digits.
Input	A	(0)4 - 20mA input.
	U	0 - 10V DC input.
Enclosures	HB	Aluminum panel mount enclosure.
	HC	GRP panel mount enclosure.
	HSB	Stainless steel 316L panel mount enclosure.
	HD	GRP field mount - Cable entry: no holes.
	HE	GRP field mount - Cable entry: 2 x Ø 16mm & 1 x Ø 20mm.
	HF	GRP field mount - Cable entry: 1 x Ø 22mm ($\frac{7}{8}$ ").
	HG	GRP field mount - Cable entry: 2 x Ø 20mm.
	HH	GRP field mount - Cable entry: 6 x Ø 12mm.
	HJ	GRP field mount - Cable entry: 3 x Ø 22mm ($\frac{7}{8}$ ").
	HK	GRP field mount, flat bottom - Cable entry: no holes.
	HQ	GRP field mount - Cable entry: 2 x Ø 16mm & 3 x Ø 12mm.
	HA	Aluminum field mount - Cable entry: 2 x PG9 + 1 x M20.
	HL	Aluminum field mount - Cable entry: 2 x $\frac{1}{2}$ "NPT.
	HM	Aluminum field mount - Cable entry: 2 x M16 + 1 x M20.
	HN	Aluminum field mount - Cable entry: 1 x M20.
	HO	Aluminum field mount - Cable entry: 2 x M20.
	HP	Aluminum field mount - Cable entry: 6 x M12.
	HT	Aluminum field mount - Cable entry: 1 x $\frac{1}{2}$ "NPT.
	HU	Aluminum field mount - Cable entry: 3 x $\frac{1}{2}$ "NPT.
	HV	Aluminum field mount - Cable entry: 4 x M20.
	HZ	Aluminum field mount - Cable entry: no holes.
	HBM	Extended Alu. field/meter mount - Cable entry: 2 x M16 + 1 x M20 (not with CSAc-us approval).
	HBO	Extended Alu. field/meter mount - Cable entry: 2 x M20 (not with CSAc-us approval).
	HBU	Extended Alu. field/meter mount - Cable entry: 3 x $\frac{1}{2}$ "NPT (not with CSAc-us approval).
	HSM	Stainless steel 316L field mount - Cable entry: 2 x M16 + 1 x M20.
	HSO	Stainless steel 316L field mount - Cable entry: 2 x M20.
HSU	Stainless steel 316L field mount - Cable entry: 3 x $\frac{1}{2}$ "NPT.	
Power	PD	16 - 30 V DC + sensor supply.
	PF	24V AC/DC + sensor supply - requires XX.
	PL	Input loop powered from sensor signal type "A".
	PM	115 - 230V AC + sensor supply - requires XX.
	PX	Basic power supply 8 - 30V DC.
Battery	PB	Additional lithium battery powered (opt.) - requires XX and PD, PL or PX.
	PC	Additional lithium battery powered (opt.) - Intrins. safe - requires XI and PD, PL or PX.
Hazardous	XI	Intrinsically safe, according ATEX, IECEx and CSA c-us.
	XF	Ex d enclosure - 3 keys according ATEX and IECEx.
	XX	Safe area only, according CE / UKCA.
Options	ZB	Backlight.
	ZX	No options.

The **bold** marked text contains the standard configuration: F070-A-HC-PX-XX-ZX.